

SWISSVOICE

D38

Quick user guide

INTRODUCTION

D38 is a 3G clamshell phone with dual display (Thanks to the E-paper Always-On external display, the user will no longer miss key information)

D38 is a CARE PHONE with dedicated features :

- Amplified Sound and Ringer
- Loud speaker
- 2M pixel camera
- Built-in large memory
- Talking dialing digits
- Auto-answer
- Compatible with Swissvoice Alarm Bracelet
- Easy charging base
- Talking caller ID name
- 20 Photo speed dial
- SOS button (5 number list)
- SwissVoice Care features

KEYS DESCRIPTION

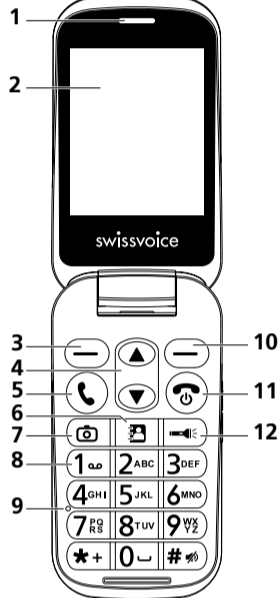

- 1 - Earpiece
- 2 - Main display
- 3 - Left selection key
- 4 - Navigation keys
- 5 - Answer/Call key
- 6 - Photo Phonebook key
- 7 - Camera Key
- 8 - Dialing keypad
- 9 - Microphone
- 10 - Right selection key
- 11 - End / Power key + turn off FM radio
- 12 - Torch key (Long press (3s) to activate/desactivate)

** # is the hot key for switching the keypad input between ABC, Abc, abc & 123.

Long Press on # will activate / deactivate the Silent mode

** *+ is the hot key for entering special symbols.

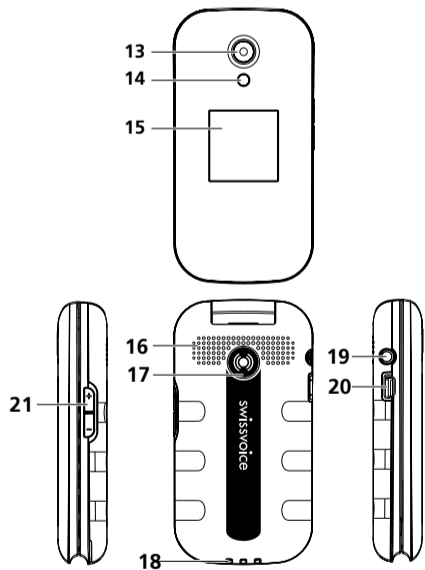

- 13 - Camera lens
- 14 - Torch LED Flashlight
- 15 - Front display
- 16 - Loudspeaker
- 17 - SOS key
- 18 - Charging contacts
- 19 - Headset jack
- 20 - Micro-USB socket
- 21 - Volume control (Hearing, Ringer and Audio Boost)

DISPLAY ICONS

External E-paper Display

- Battery LOW
- Charging
- Alarm ON
- Battery FULL
- Missed call
- New message

Color Display

- Earpiece amplification ON
- Vibrate then Ring
- Vibrate only
- Battery power
- Bluetooth ON
- Roaming

- Silence
- Headset Plugged in
- Red - Ring; Green - Ring & Vibrate
- Signal strength

Note! All the diagrams are for illustrative purposes and may be slightly different from the actual unit. In keeping with our environmental preservation and compliance commitment, we include Quick user guide in our packaging. For digital copy of user manual and useful information, please visit our website or contact our Helpline. www.swissvoice.net

GET STARTED

Installing the SIM card, memory card and battery

ATTENTION :

- Risk of swallowing small objects! The SIM card & memory card can be removed. Small children can swallow them.
- Do not bend or scratch the SIM card. Prevent any contact with water, dirt or electrical charges.
- Turn off the phone and disconnect the charger before removing the battery cover.

- Remove the battery cover:

Remove it with the help of your nail or a small flat tool, following the drawing

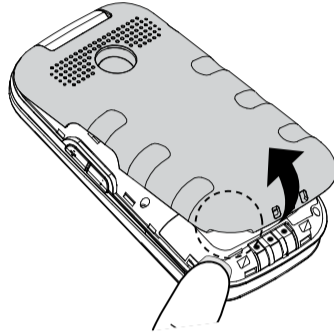

- Insert the Nano SIM card (mandatory) and the microSD memory card (optional, not supplied):

- 1) Slide the small metal part to the right side to unlock it.
- 2) With the finger nail, lift it up to the right side.
- 3) Place the SIM card in the SIM card holder with the golden contacts facing down and the cut corner at the lower left (drawing A).
- 4) Close the SIM card metal part and lock it by sliding to the left (drawing B).

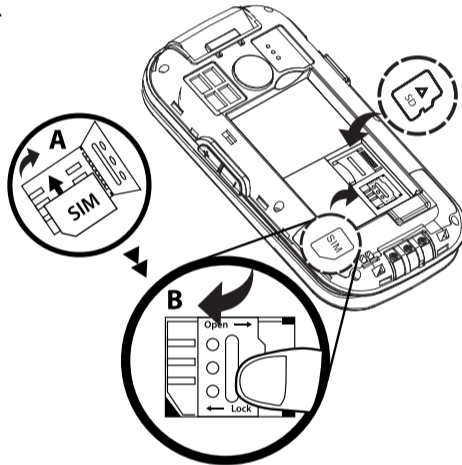

*To expand the internal storage memory, you can insert a microSD memory card (maximum capacity of 32 GB / not included).

- Insert the battery:

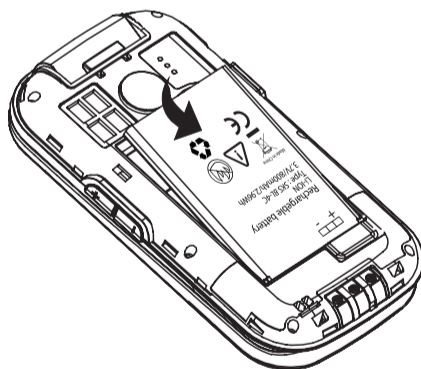

- Insert the battery into battery compartment with golden contacts of the battery facing downwards to the right of the phone. Press lightly on the top end of the battery until it snaps into place.
- Replace and secure the battery cover until it clicks into place.

Charge the phone

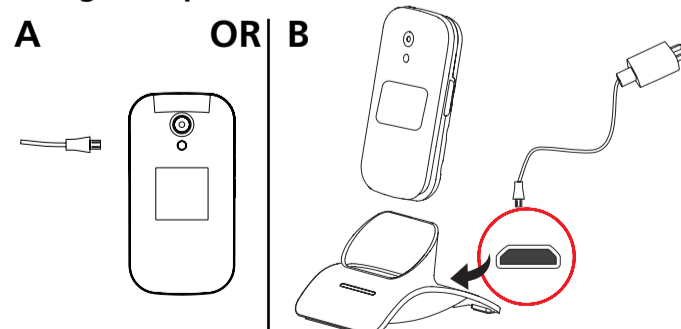

- Connect the USB plug of the adaptor to the charging socket (A) or place the device in the cradle (B) and connect the latter to the mains with the provided power adaptor.

ATTENTION:

- Only use battery, charger and accessories that have been approved for using with this particular model. Connecting other accessories may be dangerous and may invalidate the warranty.
- When charging the battery for the first time, it should be charged for at least 4 hours.

1st USE SETUP

- Long press to power up the phone. You may be requested to enter your Sim card PIN code (4 digits) provided by your operator.
- to select the desired language > OK
- Input HH:MM > > DD/MM/YYYY > > 12Hr/24Hr > > Save (Press Menu > > Settings > Phone > to modify the detailed settings)

Make a Call

- Enter the number 0.....9 (Press Clear to delete)
- Press to dial (Press H-Free for Handsfree. Press H-Held for Handset)
- Press to end the call
- To deactivate/activate the talking keypad: Menu / Settings / 1. Profiles / General / 2. Customize / 7. Keypad

Phonebook

- D38 offers a PHOTO Phonebook for 20 VIP contacts, along with a 500 contacts regular phonebook.

Add photo phonebook contact

- Press > > Add.... (Or, View > Edit..... for current contacts)
- 1. Picture > > Save (To take a new photo)
- 2. Contact > input the name and number > Save
- 3. Caller ringtone > Record > record the name/voice message > Stop > Play (to check)
- When one of these contacts calls in, the associated voice message will be announced. If no voice message is recorded, the phone will ring with normal ringtone.

Add Phonebook contact:

First contact:
Press Menu / / Phonebook / / 2. Normal / Options / Name, input ABC... / / Number, 012..... / / Caller ringtone, ... / Options / Save

Then for additional contacts:

Press Menu / / Phonebook / / 2. Normal / / Add / Options / Name, input ABC... / / Number, 012... / / Caller ringtone, ... / Options / Save

Call from phonebook

- Press > to select the 20 photo memories; or Press Names > to select the number
- Press to dial
- Press to end the call

Receive a Call

- Flip up the phone or press to answer
- Press to end the call

Settings (Ring tone & Volume)

- Press Menu > > Settings >....
- Under the Settings menu, the following options can also be accessed

 1. Profiles : to set ringers, volume, keypad tone..(General/Options/Customize...)
 2. Phone : to set Time/Date, Language, Display (wall paper, backlight)
 3. Charger LED (Activate / Deactivate)
 4. Tone Control
 5. Call settings
 6. Security (password : 1122)
 7. Restore (password : 1122)

Call Log

- Press Menu > > Call Log >....

 1. Missed
 2. Dialed
 3. Received

(Or press to get all calls list)

 - Press to select the desired number
 - Press to dial out

Write/Send Messages (SMS/MMS)

- Press Menu > > Messages > Write > to select SMS or MMS (You can also press > Write >)
- Input the text messages or attachment for MMS

** # is the hot key for switching the keypad input between ABC, Abc, abc & 123.

** *+ is the hot key for entering special symbols.

- Press Options > Send to > > Enter number or Add from phonebook > enter the recipient phone number > OK > Options > Send
- Under the Messages menu, the following options can also be accessed

 1. Write
 2. Inbox
 3. Drafts
 4. Outbox
 5. Sent
 6. Setting

Read new messages



- Press View > to select message
- Press View to read

- Press **Options** to Reply / Forward / Delete

Read old messages

- Press **Menu**
- Press **OK**
- Select **Inbox**

Take a Photo











- Press  > press again  to take a photo.....

(Press **Menu** >  > **Multimedia** > **Gallery**.... to review pictures)

Multimedia

- Press **Menu** >  > **Multimedia** >.....
 1. **Camera**
 2. **Gallery**
 3. **Play Audio**
 4. **Recorder**
 5. **FM Radio**

FM Radio

- Quick access: Press  (or **Menu** >  > **Multimedia**) > **FM Radio**
- Press  to play,  to pause (using )
- Press  to scan next station (using )
- Radio Channel selection : Press  > **Options** > **Auto search** > **Yes**
- To turn off radio: Press  >  > **Yes**

UNIQUE FEATURES HIGHLIGHT

SOS Assistance button

- Long press  for 3 seconds to dial out assistance number/s
- Follow the voice message, the recipient of the assistance call can press **0** to accept the call. **D38** will enter the handsfree mode automatically
- If the call was not accepted, **D38** will keep dialing out until the call is accepted

- To terminate, press and hold 

SOS mode Setting :

- Press **Menu** >  > **SOS Settings** > **1. SOS Mode Setting**
 1. **SOS numbers** (SOS button to call 5 Emergency numbers)
 2. **Service center** (SOS button to call Service center number if available)
 3. **OFF** (SOS button is deactivated)
- Press **OK** to select

SOS number Setting :

- Press **Menu** >  > **SOS Settings** > **2. SOS Number**
- Select the numbers (5 Max). **Options** or **Edit** can be selected
 1. **Add From Phonebook**
 2. **Add From Photo phonebook**
 3. **Enter number**
- Press **Done** or **OK** to save

Service Center number setting :

- Press **Menu** >  > **SOS Settings** > **3. Service Center**
- Enter the number and press **Done**

Voice Message :

- Press **Menu** >  > **SOS Settings** > **4. Voice message**
 1. **Default** > **Select** – Default voice message announced to the recipient of the assistance call
 2. **Custom** > **Select** – User recorded voice message announced to the recipient of the assistance call

⚠ATTENTION :



- Remember to set the **SOS** numbers and inform all the recipients.
- To have **SOS** function working normally, the network service must be active.

Talking Dialing Digits

- While pressing the numeric buttons, D38 will announce the corresponding number.
- (Press **Menu** > **Settings** > **Profiles** > **General** > **Customize** > **Keypad**..... to select among Talking dialing digits, Silence or Key tone.)

Talking Caller ID Name

- You can record a name/message associated to the **PHOTO** phonebook contacts. When the incoming caller number matches the phone number in the photo phonebook , the corresponding recorded name/message will be announced instead of the normal ring melody.

(Press  >  > **View** > **Edit** > **Caller ringtone** >..... to delete the recorded message and restore the normal ringtone)

Torch

- Make a long press  to turn ON/OFF

SMART TOOLS

Helper

- Remember to set **Helper** mobile phone number for SMS alert notification for i.Ringer, s.Notification and Smart Care.

(Press **Menu** >  > **Helper**.....)

Remark : Sending SMS may require additional cost!

Intelligent Ringer

- In order not to miss a call, the ringer loudness will automatically set to maximum when the same phone number calls the second time within 3 minutes after the initial missed call.
- After the call is answered, the ringer loudness will be resumed to the user selected volume level.

(Press **Menu** >  > **i.Ringer**.....to switch this feature ON/OFF)

Smart Notification

- SMS will be sent to the **Helper** (Mobile phone number) for **MISSED CALL** (1 to 10 missed call configurable) or **BATTERY LOW** of your phone.

- **Helper** mobile phone number can be set under the same Smart Tools menu.

(Press **Menu** >  > **s.Notices**.....)

Smart Care

- SMS will be sent to the **Helper** (Mobile phone number) for **LACK of PHONE CALL ACTIVITIES** or **LACK of PHYSICAL ACTIVITIES** (key detect, open/close of the phone, charging detection).
- **Helper** mobile phone number can be set under the same Smart Tools menu.

(Press **Menu** >  > **Smart Care**.....)

Auto Answer

- D38 answers incoming calls automatically in speakerphone mode at maximum volume when incoming calls of one of the authorized Care Taker phone numbers (Maximum of 5 preset phone numbers) are not answered the 3rd time within 3 minutes.

(Press **Menu** >  > **Auto-Answer** > **Care Taker**)

SOS bracelet option

1. Activate Bluetooth on D38 : Press **Menu** > **Network** > **Bluetooth** > **Power ON / Visibility ON**.
2. Pair SOS bracelet : **Menu** > **Network** > **Bluetooth** > **Pairing**...
3. Use SOS bracelet : SOS number has to be registered in D38 (see SOS number setting)...

TECHNICAL DATA

GSM - 850 / 900 / 1800 / 1900 MHz
 3G - 850 / 900 / 2100 MHz or 850 / 1900 / 2100 MHz
 Additional function - Bluetooth
 Battery - Li-Ion, 3.7 V, 800 mAh
 Earpiece volume - Maximal +35 dB
 Talk time - up to 5 hours
 Standby time - up to 7 days
 Dimensions - approx. 107 x 56 x 20 mm (closed)
 approx. 200 x 56 x 12 mm (open)
 USB connection - Micro USB
 Headset connection - 3.5 mm jack, 4-conductor (TRRS) phone connector
 SAR values - GSM Head: 0.14 / Body: 0.95 W/kg
 3G Head: 0.11 / Body: 0.51 W/kg

PROBLEMS AND SOLUTIONS

Problems	Solutions
The mobile phone cannot be switched on	No battery inserted; Battery is not charged.
The phone is requesting a PUK when I switch on the phone	If you do not have the PUK for your SIM card, please contact your service provider.
No signal quality is displayed	No network connection. The mobile phone is in a location where there is no network service, please move to a different location or contact your service provider
A message appears in the display for some functions, indicating execution/use is not possible	Some functions can only be used after the respective service has been applied for. Contact your service provider.
Screen frozen or no response when pressing keys	Remove the battery for 3 minutes and try again
No connection to the mobile telecommunication network	Contact your service provider
The "Insert SIM" message appears in the display	Ensure that the SIM card has been installed correctly. Contact your service provider.
The battery cannot be charged or is empty within a short time	Battery is defective; Place the phone correctly in the charging unit or connect the charging unit properly; Clean the charging contact of the mobile phone and charging unit with a dry soft cloth; Charge the mobile phone for 4 hours.
The mobile phone has accidentally got wet	Switch off the phone immediately, remove the battery and allow the unit to dry completely before powering it on again.
you cannot send any SMS or MMS solution	Press MENU > Network ... (If you do not have the APN for your SIM card, please contact your service provider)

TIPS ON THE BATTERY

- Only use batteries, cables and charging unit approved by the manufacturer, otherwise the battery could be damaged.
- Do not short circuit the battery. Always leave the battery in the phone to avoid accidentally short circuiting the battery contacts.
- Keep the battery contacts clean and free of dirt.
- The battery can be charged/discharged hundreds of times but its service life is limited. Replace the battery when the battery power has decreased noticeably.

NETWORK SERVICES AND COSTS

D38 is designed for use when connected to a mobile phone network. Using network services and SMS may result in traffic costs.

AREA OF USE

- Do not use the phone in prohibited areas.
- Switch the phone off without affecting nearby medical equipment (e.g. in hospitals).
- Do not use the phone in petrol stations or near fuels and chemicals.

SAFETY

- Prevent exposure to smoke, dust, vibration, chemicals, moisture, heat and direct sunlight.
- The phone is not waterproof, please keep it dry.
- Only use original accessories and battery. Never attempt to connect other products.
- Never attempt to connect incompatible products.
- Repairs to this device must be completed by qualified service personnel.
- Keep the phone and accessories out of the reach of children.
- The SIM card can be removed. Caution! Small children can swallow them.
- The ringing tone is issued via the loudspeaker. Take an incoming call first and then hold the phone to your ear. This prevents any possible hearing damage.
- Use approved handsfree equipment and appropriate holder while driving. It is essential to observe the applicable national laws and regulations.
- Always maintain a distance of at least 15 cm to implanted heart pacemakers to prevent interference. Do not carry the phone in a chest pocket when switched on. Always hold the phone to the ear furthest away from the pacemaker during calls. Switch the phone off immediately if you notice or suspect any adverse effects. Consult your doctor if you have any question.
- This phone is hearing aid compatible. If you wear a hearing aid, please contact your doctor or the hearing aid manufacturer to inquire about any possible impairments through mobile communication equipment.
- Do not rely on the mobile phone as a safeguard for emergencies. For a variety of technical reasons, it is not possible to guarantee a reliable connection under all circumstances.
- Ensure access to the power adapter plug is not obstructed by furniture or such.

ENVIRONMENT

 This symbol means that your inoperative electronic appliance must be collected separately and not mixed with the household waste. The European Union has implemented a specific collection and recycling system for which producers are responsible

Help us protect the environment in which we live!



DECLARATION OF CONFORMITY

The logo printed on the products indicates the conformity with all essential requirements (RED directive : 2014/53/EU). You can download the Declaration of Conformity from our website - www.swissvoice.net

WARRANTY

Please read carefully the user guide included in this box. D38 is an approved equipment in accordance with the European regulations, attested by the CE marking. The product you just bought is a technological product, it must be handled with care.
 Note: You have a legal warranty on this product in accordance with the regulations applicable to the sale of consumer goods in the country in which you made this purchase. For any information regarding this legal warranty, please contact your dealer. Without prejudice to the legal guarantee of the products, ATLINKS guarantees that the product in this box conforms to its technical specifications contained in the user guide included in the this box, and this during a warranty period, counted from the date of purchase of the new product, the date on your invoice or ticket checkout where is indicated the name of your reseller, and equal to: Twenty four (24) months for the telephone, excluding consumables, accessories and batteries. For any claim under this warranty during the warranty period, you must return the entire Product to your dealer, together with the proof of purchase, the invoice or receipt issued by your dealer, indicating the place of purchase and the serial number of the Product, following the appearance or discovery of the defect. ATLINKS undertakes to repair any defective item due to a defect in design, material or workmanship, at its expense, or to replace, at its expense, by an identical or at least equivalent element in terms of functionalities and performance. If the repair or replacement is impossible under normal commercial conditions, the Product will be refunded or replaced by a Product equivalent. Within the maximum limit allowed by the applicable law, the product or element replacement, which may be new or reconditioned, is warranted during a period of ninety (90) days from the date of repair or until the end date of the initial warranty period, whichever is the earlier greater than ninety (90) days, it being specified that any period of immobilization of the Product of at least seven (7) days will be added to the warranty period remaining to run. This warranty does not apply in the following cases:
 - Installation or use not in accordance with the instructions in the guide of the user,
 - Incorrect connection or abnormal use of the Product, especially with non-compatible accessories, as indicated in the user guide,
 - Product opened, modified or replaced by means of non-approved parts, serial number deleted, illegible, damaged,
 - Normal wear, including normal wear and tear on accessories, batteries and displays,
 - Failure to comply with the technical and safety standards in force in the area geographical use,
 - Product having suffered a shock or a fall,
 - Product damaged by lightning, electrical surge, heat source or radiation, water damage, exposure to conditions of temperature, humidity or other excessive ambient conditions or any other cause external to the product,
 - Negligence or faulty maintenance,
 - An intervention, a modification or a repair carried out by a not authorized by ATLINKS. If the returned Product is not covered by the warranty, you will receive a quote from repair that will mention the cost of analysis and transportation costs that you will be charged if you want the Product returned to you. This guarantee is valid in the country in which you regularly purchased the Product, provided that the country is a member of the European Union. Subject to the legal provisions in force, all warranties other than described herein are expressly excluded.
 TO THE MAXIMUM EXTENT PERMITTED BY APPLICABLE LAW,
 A) THIS WARRANTY IS EXCLUSIVE TO ALL OTHER WARRANTIES EXPRESS OR IMPLIED, INCLUDING, BUT NOT LIMITED TO, WARRANTIES OF MERCHANTABILITY OR FITNESS FOR A PARTICULAR PURPOSE PARTICULAR;
 B) ATLINKS DISCLAIMS LIABILITY FOR LOSS OR DETERIORATION OF DATA, LOSS OF USE LOST TO WIN, LOSS OF CHANCE, DERIVATIVES OR INCOME, LOSS OF OPERATION, DAMAGES INDIRECT, CONSEQUENTIAL, CONSEQUENTIAL OR INCIDENTAL;
 (C) ATLINKS LIABILITY IS LIMITED TO THE VALUE OF PURCHASE OF PRODUCT EXCEPT HEAVILY OR UNINTENTIONAL FAULT AND EXCEPT DAMAGE BODY

The Manufacturer reserves the right to modify the specifications of its products in order to make technical improvements or comply with new regulations.

ATLINKS
 147 avenue Paul Doumer
 92500 RUEIL-MALMAISON France
 RCS Nanterre 508 823 747
 © ATLINKS 2019 - Reproduction prohibited.
www.swissvoice.net

Swissvoice is a trademark of Swissvoice International SA.

© Copyright Swissvoice International SA 2019

Model : Swissvoice D38
 A/W No. : 10002144 Rev.0 (EN)
 Printed in China