

G50

Instructions Manual

INTRODUCTION

- G50 is Swissvoice's new smartphone for seniors. Its many features include:
- 1 - Easy-to-use interface, with two modes to choose from (Simple and light Android)
 - 2 - Text <=>Speech support for messages, dialling, etc
 - 3 - SOS button
 - 4 - Desk top easy-charging base

PRODUCT DESCRIPTION

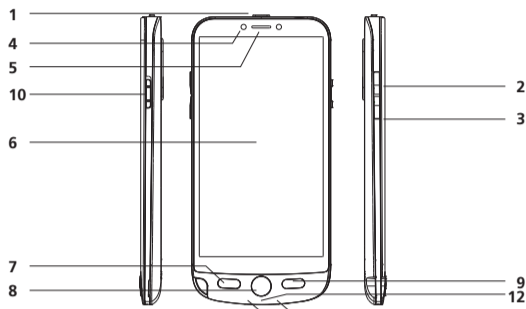

- 1 - Turn ON/OFF the screen; Power ON/OFF (Long press)
- 2 - Volume up key
- 3 - Volume down key
- 4 - Front camera
- 5 - Receiver
- 6 - Touch screen
- 7 - Task manager key (Android mode)
- 8 - Home key
- 9 - Back key
- 10 - Torch sliding switch
- 11 - Charging contacts
- 12 - USB connector

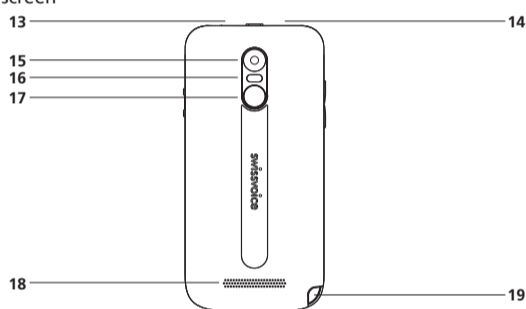

- 13 - Flashlight LED
- 14 - Headset jack
- 15 - Main camera
- 16 - Flash
- 17 - SOS button
- 18 - Speaker
- 19 - Lanyard hole

PACKAGE CONTENT

1. G50 smartphone
2. Easy-charging base
3. Power adaptor with USB cable
4. Instructions manual
5. Battery
6. Battery cover
7. Earphones

GET STARTED

Insert the SIM card (required) and the memory card (optional)

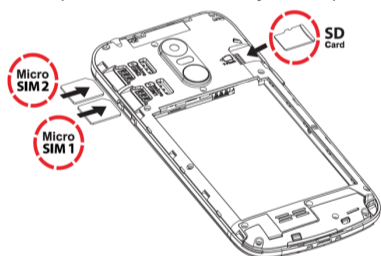

- With the SIM card golden contacts facing down, insert the SIM card into one of the available slots until it stops as illustrated
- To expand the internal storage memory, you can insert a microSD memory card (maximum capacity of 64 GB / not included). Insert the memory card into the slot until it stops as illustrated

Note: Both card slots (SIM1=Micro, SIM2=Micro) support LTE (4G). If nano SIM card is used, a SIM card adaptor is required (provided by operator)

ATTENTION:

- Risk of swallowing small objects! The SIM card & memory card can be removed. Small children can swallow them
- Do not bend or scratch the SIM card. Prevent any contact with water, dirt, or electrical charges
- Turn off the phone and disconnect the charger before removing the battery cover

Insert the battery

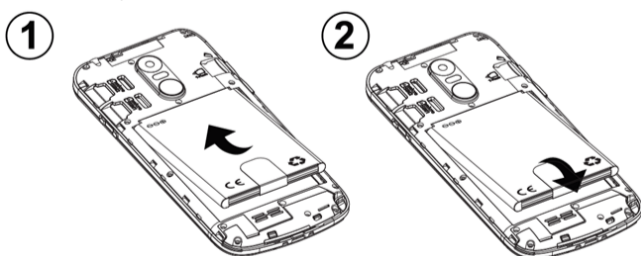

- Insert the battery into battery compartment with golden contacts of the battery pointing to the top right of the phone
- Press lightly on the bottom end of the battery until it snaps into place

Replace the battery cover

Replace and secure the battery cover until it clicks into place

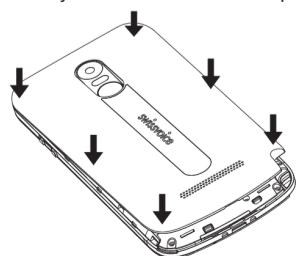

Charging your phone

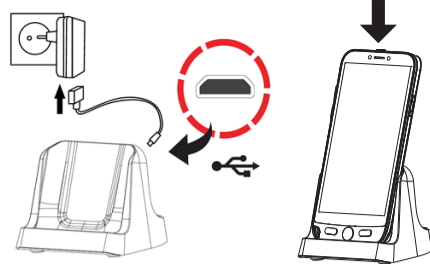

- Place your easy-charging base on a flat surface for more stability
 - Plug provided USB cable to the charger on one end, and to a wall mains socket on the other side
 - To charge your phone, simply place it on the charger as depicted
- G50 can also be charged as a regular smartphone by plugging the USB cable directly on the USB connector (12)

ATTENTION:

- Only use battery, charger and accessories that have been approved for using with this model. Connecting other accessories may be dangerous and may invalidate the warranty.

Getting started guide

- **Please read this "Getting Started guide" CAREFULLY before start using your Swissvoice G50.
- **Google account is required for your phone to receive software updates. Please sign in during phone set up or later.
1. Long press ON/OFF button (1 in the figure) to power up the phone
 2. The display will be lighted up
 3. Enter the SIM PIN code (Optional : Service provider dependent)
 4. Select the desired language
 5. Follow the setup wizard steps on the screen
 6. When completed, swipe with your finger on the touch screen and press **Select Home** icon on page 2, to choose between Simple Smartphone and light Android modes



Simple Smartphone mode offers an extremely easy to use interface, specifically designed for senior users. Check next chapter to learn about phone operation in this mode.

Light Android mode presents the user with a simplified version of a regular smartphone. If you chose this mode, please read "USING YOUR G50 IN LIGHT ANDROID MODE".

USING G50 IN SIMPLE SMARTPHONE MODE

When Simple smartphone mode is selected, your G50 will look simpler and easier to use than a regular smartphone.

Setup Wizard

- The first time you select Simple Smartphone mode, you will have the choice to be guided along the most relevant settings by a Setup Wizard. These are:
- a. Click Duration (sets click duration for alphanumeric keyboard and other keys**)
 - b. Wifi setup (if Wifi internet access is available)
 - c. Google Account
 - d. Copy Contacts
 - e. New Contacts
 - f. SOS and Support
 - g. Speed Dial
 - h. Favorite Contacts
 - i. WhatsApp
 - j. Advanced Settings
 - k. Exit Setup

Once you "Exit Setup", the wizard is always available under Settings.
** Note all touch-screen clicks are by default long click when using Simple Smartphone mode. A valid key press should have a confirmation vibration.
Click duration can be changed anytime through the wizard or in Advanced Settings.

Home Screen

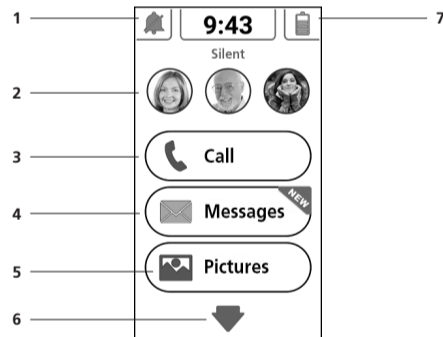

- 1 - Silent / Vibrate only / Normal mode
- 2 - One Touch Speed Dials
- 3 - Calls Center
- 4 - Message Center - SMS, missed calls, WhatsApp, etc.
- 5 - Pictures Center - View photos and videos, use the camera
- 6 - Other functions such as Whatsapp, phonebook, applications, settings, etc
- 7 - Battery level

Turn the Phone ON/OFF

- Long press ON/OFF button (1 in the figure)
- The display will be lighted up. (To turn off the phone: **Power Off > Turn off**)

Call from the 3 One-Touch speed dials

- Press one of the 3 One-Touch speed dials directly (2 in the figure)
- Press to end the call

Make a call

- Press **Call** > **Dial number** > Enter the number 0.....9 (Press Del to delete)
- Press to dial
- Press to end the call

Call from phonebook

- Press **Call** > to search and select the number OR
- Press **Call** > **Search** > enter the 1st character of the contact > **Search** > select the number
- Press to dial
- Press to end the call

Call Log

- Press **Call** > **Call Log** or **Phonebook** > **Call Log** to view the call log
- To call back the incoming call number, press the number

Receive a call

- Press to answer
- Press to end the call

Adjust the earpiece loudness

- During a call, press Volume up/Volume down keys - to adjust the loudness

Ringer mode

- In idle mode, press > select the ringer mode between **Sound / Silent / Vibrate**

Message

- All types of messages (SMS, WhatsApp, missed call, etc...) are consolidated in Message
- When there is a new message, the button will be highlighted with a new indication
- To read the message, press on the new items to read the details or press **Read old message**.....

Write new message

- **Message** > **Write a new message**
- Input the sending number by **Dial number** > **Next** OR
- Select from existing phonebook with
- Input from Keyboard > **Send** OR
- Select the pre-defined simple message by **Next**

Pictures

- **Pictures** > **View Pictures** > move to the next.....
- (Press **All images** to see all pictures > / to scroll through them)

Camera

- **Pictures** > **Take a picture** > **Camera** > **Capture** to take photo or **Record** to take video
- Remember to **Save** or **Save and Send** the photo.....

Phone Book

Options in this menu:

1. View
2. Edit
3. New Contact
4. Call Log

ADD New contact

- **Phone Book** > **New Contact** (or **Settings** > **Contacts** > **New**)
- **Name** > input the name > **Next**
- **Number** > input the number > **Next**.....
- **Save**
- You will be asked if you wish to Add a photo from Images or from Camera. Press Yes or No and follow the instructions on the screen

EDIT Contact

- **Phone Book** > **Edit** (or **Settings** > **Contact** > **Update**)
- Select a contact for editing
- **Name** > Edit the name > **Next**
- **Number** > Edit the number > **Next**.....
- **Save** (To associate a photo to a contact, go to **Settings** > **Contacts** > **Photo**)

Settings

- **Settings** >
- Under the Settings menu, the following options can also be accessed:

 1. Contacts
 2. Speed Dial
 3. Language
 4. Advanced Settings
 5. Setup Wizard
 6. Premium Service

Edit the 3 One-Touch Speed Dial buttons

- **Settings** > **Speed Dial**
- Select the empty button
- Choose the number from contact list (to next page)
- **Add contact to list** (Add speed dial photo..... Go to **Settings** > **Contacts** > **Photo**)

Add new contact to Favorite contacts in CALL button

- **Settings** > **Contacts** > **Favorite**
- Select the empty button
- Choose the number from contact list (to next page)
- **Add contact to list** (Favorite contacts can be selected by pressing **Call**)

Click duration

Long press duration for menu buttons and text keyboard can be adjusted to be faster or slower: **Settings** > **Setup Wizard** > **Click Duration**

Advanced Settings

- **Settings** > **Advanced Settings**
- Under the Advanced Settings menu, the following options can also be accessed:

 1. Initial setting
 2. Contacts
 3. Personal Info
 4. SOS and Support
 5. Android settings
 - Ringer melody and Volume
 - Wifi
 6. Medication Reminder
 7. Display & Sound settings
 8.

Talking Dialling Digits

- While pressing the numeric buttons, G50 will announce the corresponding number (except when in silent mode)
- (To disable this feature, go to **Advanced Settings** menu > **Display & Sound Settings** > **Sound Settings**.....)

SOS Assistance button

- Long press SOS button (17) for 3 seconds to dial out assistance numbers
- G50 will enter handsfree mode automatically
- In parallel, an SMS with geolocation information will be sent to the recipient of this assistance call and up to other 5 recipients. (To stop the SOS action: Long press **CANCEL**)

Set SOS number

- Make sure the desired phone number exists in the phonebook.
- **Settings** > **Advanced Settings** > **SOS and Support** > **SOS number** > Select the numbers..... **Save**
- An SMS will be sent to the selected numbers to inform them

ATTENTION:

- Remember to set the SOS number and inform the recipient
- To have SOS function working normally, the network service must be active
- Sending SMS may require additional cost!

Torch

To switch on/off the flashlight, slide up or down the torch switch (10) located on the left-hand side of the phone.

USING YOUR G50 IN LIGHT ANDROID MODE

When light Android mode is selected, your G50 will show a simplified smartphone interface, with large icons and easy-to-navigate pages.



- 1 - Google search
- 2 - Messages
- 3 - Chrome
- 4 - Apps area, swipe right/left for more pages
- 5 - Notification area, drag down to see more details or open configuration

Make a call

- Tap on **Phone** icon on the applications menu
- Click on the dial pad icon at the bottom of the screen
- Enter the phone number and then click the dial key
- Press and hold 0 key if you need to add a (+) sign for international calls prefix (See **Contacts** section to dial phonebook entries)
- While on communication you can use the icons to activate handsfree, mute, get the keypad to dial an extension or add another call
- To end the call, press on

Answer a call



- When a call is received, a pop up window will be shown
- Press green **ANSWER** button to accept or **DECLINE** to reject

Call Logs

- To access recent calls: **Phone > Recents** tab
- To access full call log: **Phone > ⋮ > Call History**
- To dial a number in the call log, click the dial icon
- To get more options, click on the number
- Long click on the number to copy or delete the record
- To clear the call logs, from Call History press the menu key ⋮ > Clear

Contacts



To enter, tap on **Contacts** icon on the applications screen

- All contacts (SIM card, google account, phone contacts) will be displayed by default, and in alphabetical order
- Click on Search icon  to enter the contact search interface
- Click on Menu icon  to access other functions (help, create labels, manage contacts settings)

Add New Contact

- **Contacts > +** (Or, from **Phone > Contacts**, press on **Create new contact**)
- Choose to save the contact to your Google Account, SIM, or phone
- You may enter different contact details which include adding a picture, name, telephone number, group, address, and email among other options
- Click **Save**

Delete Contact

- Long press on the contact. You can choose multiple contacts to delete. Press 
- You may also search for an individual contact in the phonebook, click to select, press menu key , and **Delete**

Call one of your contacts

- Enter **Contacts** app (or **Phone** app > **Contacts** tab)
- Browse or search your contact, click on it
- Then click again on the phone icon

Import / Export Contacts

You can import and export contacts to synchronize information between different storage types (SIM card, Google account and your phone).

To import or export contacts:

1. Enter **Contacts** app
2. Press the menu icon  and select **Settings**, go down to **Import / Export**
3. Select the source you want to copy the contacts from, then click next and select the destination. Then select the desired contacts to be copied

Messages

Exchange text and multimedia messages with your family and friends. Messages to and from the same phone number will be saved into a single conversation.

Send an SMS

- Enter **Messages > Start chat**
- Enter a contact name or number, or select from the list
- Compose Text Message and click send icon 







Send an MMS

- Start by writing a regular SMS
- Click the attachment icon  in the messaging interface
- Click to add attachments and create an MMS message

Notifications Bar

The notification bar located on the top of the screen contains information regarding your phone and installed apps.

The notification settings window provides shortcuts to different phone settings for quick access. Click on any of the shortcut notification icons

(     ) to power on or off.



Drag the notification bar down with your finger to display any pending notifications or actions.

To clear, drag to your right.

Power on Bluetooth

- Drag down the notification bar and click on Bluetooth icon  to enable
- Or **Settings  > Connected devices > Connection preferences > Bluetooth** and switch Bluetooth on. Bluetooth icon will appear in the notification bar
- Click on “Pair new device” to see a list of available devices within the phone’s range. You can pair with an available device by clicking on it
- **Settings > Connected devices** will list available devices



Power on Wi-Fi

- Drag down the notification bar and click on Wifi icon  to enable
 - Or **Settings  > Network & Internet > Wi-Fi** and select ON to power on Wi-Fi
 - Click on the desired Wi-Fi network to be connected
- Note:** Secured networks require a password or credentials prior to connection.

Camera

Optional: You may want to insert an SD card before using the camera or video camera for larger storage capacity.

Take Pictures

- **Camera >** press the Shutter  on the screen to capture image
- To view your picture, click on the Preview box button or go to **Gallery > Camera** folder
- Click on Picture/Video icons to switch capture mode
 - Tap on  to switch between normal and selfie modes
 - Tap on  to open flash mode selection interface

Gallery

Gallery is your image center. With Gallery you can view, organize, edit, and share your pictures and videos.

Google folder > **Gallery** > Tap on any image. Then use the bottom menu to edit or share to your contacts.

Settings

Settings gives access to phone configuration parameters. For a comprehensive list, check the full user guide.

Change language

- **Settings > System > Language and input > Language**

Change sound settings

- **Settings > Sound**
- Use this menu to configure volume and melodies for calls, notifications, multimedia, etc. Some of the settings include vibration, volume, ring tones, ring tones notification, dial touch pad, and haptic feedback and tones.

Torch

To switch on/off the flashlight, slide up or down the torch switch (10) located on the left-hand side of the phone.

SOS Assistance button

- Long press the SOS button (17) for 3 seconds to dial out assistance numbers
- G50 will enter handsfree mode automatically
- In parallel, an SMS with geolocation information will be sent to the recipient of this assistance call and up to other 5 recipients (To stop the SOS action: Long press CANCEL)

Set SOS number

- Make sure the desired phone number exists in the phonebook
- From the applications screen, tap on **SOS Numbers** icon
- Select the numbers..... **Save**

An SMS will be sent to the selected numbers to inform them

ATTENTION:

- Remember to set the SOS number and inform the recipient
- To have SOS function working normally, the network service must be active
- Sending SMS may require additional cost!

Video calls with Duo

Duo is Google’s app for video calls.

To video call a contact: **Google** folder > **Duo** > Click on a contact > Video call.

SWITCHING G50 MODE

Switch from Android to Simple Smartphone mode

- From Android, click on **Select Home** app
- Press **Simple Smartphone** button



Switch from Simple Smartphone to Android mode

- From Home screen, go to **Tools > Exit System**
- Click on **Select Home** app
- Press **Android** button



TECHNICAL DATA

Dual SIM cards	SIM + 4G USIM; dual standby
HAC	M4/T4
Processor	MTK6739WA (1.3GHz Quad core Arm Cortex-A7)
OS	Android 10Go
Memory	RAM: 1GB ROM: 16GB
Camera	Rear: 5 Mpx Front: 2Mpx
Mobile data	2G GPRS, 3G: WCDMA, 4G:FDD-LTE
Battery	Li-Ion, 2700mAh / 4.35V
Talk time	Up to 8h
Standby time	Up to 300h
Dimensions / Weight	Approx 145x70x5mm /160g
USB jack	Micro USB
Headset connection	3.5 mm
Network bands (MHz) / Maximum power (dBm):	- GSM 2G: 850/ 33, 900/ 33, 1800/30, 1900/ 30 - 3G: 1 [2100]/ 24, 8 [900]/ 24 - 4G : 1 [2100]/ 24, 3 [1800]/ 24, 7 [2600]/ 24, 20 [800]/ 24 - Bluetooth: 2400 – 2480 / 10 - WiFi IEEE802.11b/n/g 2412 – 2472 / 20
SAR Values (W/Kg)	2G: Head: 0.224; Body: 0.525; Limb: 1.265 3G: Head: 0.130; Body: 0.502; Limb: 1.045 4G: Head: 0.097; Body: 0.670; Limb: 2.226 WiFi: Head: 0.190; Body: 0.058; Limb: 0.891

PROBLEMS AND SOLUTIONS

Problems	Solutions
The mobile phone cannot be switched on	No battery inserted; Battery is not charged.
The phone is requesting a PUK when I switch on the phone	If you do not have the PUK for your SIM card, please contact your service provider.
No signal quality is displayed	No network connection. The mobile phone is in a location where there is no network service, please move to a different location or contact your service provider
A message appears in the display for some functions, indicating execution/ use is not possible	Some functions can only be used after the respective service has been applied for. Contact your service provider.
Screen frozen or no response when pressing keys	Remove the battery for 3 minutes and try again
No connection to the mobile telecommunication network	Contact your service provider
The “Insert SIM” message appears in the display	Ensure that the SIM card has been installed correctly. Contact your service provider.
The battery cannot be charged or is empty within a short time	Battery is defective; Place the phone correctly in the charging unit or connect the charging unit properly; Clean the charging contact of the mobile phone and charging unit with a dry soft cloth; Charge the mobile phone for 4 hours.
The mobile phone has accidentally got wet	Switch off the phone immediately, remove the battery and allow the unit to dry completely before powering it on again.

TIPS ON THE BATTERY

- Only use batteries, cables and charging unit approved by the manufacturer, otherwise the battery could be damaged.
- Do not short circuit the battery. Always leave the battery in the phone to avoid accidentally short circuiting the battery contacts.
- Keep the battery contacts clean and free of dirt.
- The battery can be charged/discharged hundreds of times but its service life is limited. Replace the battery when the battery power has decreased noticeably.

NETWORK SERVICES AND COSTS

G50 is designed for use when connected to a mobile phone network. Using network services and SMS may result in traffic costs.

AREA OF USE

- Do not use the phone in prohibited areas.
- Switch the phone off without affecting nearby medical equipment (e.g. in hospitals).
- Do not use the phone in petrol stations or near fuels and chemicals.

SAFETY

- Prevent exposure to smoke, dust, vibration, chemicals, moisture, heat and direct sunlight.
- The phone is not waterproof, please keep it dry.
- Only use original accessories and battery. Never attempt to connect other products.
- Never attempt to connect incompatible products.
- Repairs to this device must be completed by qualified service personnel.
- Keep the phone and accessories out of the reach of children.
- The SIM card can be removed. Caution! Small children can swallow them.
- The ringing tone is issued via the loudspeaker. Take an incoming call first and then hold the phone to your ear. This prevents any possible hearing damage.
- Use approved handsfree equipment and appropriate holder while driving. It is essential to observe the applicable national laws and regulations.
- Always maintain a distance of at least 15 cm to implanted heart pacemakers to prevent interference. Do not carry the phone in a chest pocket when switched on. Always hold the phone to the ear furthest away from the pacemaker during calls. Switch the phone off immediately if you notice or suspect any adverse effects. Consult your doctor if you have any question.
- This phone is hearing aid compatible. If you wear a hearing aid, please contact your doctor or the hearing aid manufacturer to inquire about any possible impairments through mobile communication equipment.
- Do not rely on the mobile phone as a safeguard for emergencies. For a variety of technical reasons, it is not possible to guarantee a reliable connection under all circumstances.
- Ensure access to the power adapter plug is not obstructed by furniture or such.

ENVIRONMENT

 This symbol means that your inoperative electronic appliance must be collected separately and not mixed with the household waste. The European Union has implemented a specific collection and recycling system for which producers are responsible

Help us protect the environment in which we live!

DECLARATION OF CONFORMITY

The logo printed on the products indicates the conformity with all essential requirements (RED directive : 2014/53/EU). You can download the Declaration of Conformity from our website - www.swissvoice.net



WARRANTY

Please read carefully the instructions manual included in this box, and/or the full user guide available at www.swissvoice.net/documentation. G50 is an approved equipment in accordance with the European regulations, attested by the CE marking. The product you just bought is a technological product, it must be handled with care.

Note: You have a legal warranty on this product in accordance with the regulations applicable to the sale of consumer goods in the country in which you made this purchase.

For any information regarding this legal warranty, please contact your dealer. Without prejudice to the legal guarantee of the products, ATLINKS guarantees that the product in this box conforms to its technical specifications contained in the user guide included in the this box, and this during a warranty period, counted from the date of purchase of the new product, the date on your invoice or ticket checkout where is indicated the name of your reseller, and equal to: Twenty four (24) months for the telephone, excluding consumables, accessories and batteries. For any claim under this warranty during the warranty period, you must return the entire Product to your dealer, together with the proof of purchase, the invoice or receipt issued by your dealer, indicating the place of purchase and the serial number of the Product, following the appearance or discovery of the defect. ATLINKS undertakes to repair any defective item due to a defect in design, material or workmanship, at its expense, or to replace, at its expense, by an identical or at least equivalent element in terms of functionalities and performance. If the repair or replacement is impossible under normal commercial conditions, the Product will be refunded or replaced by a Product equivalent. Within the maximum limit allowed by the applicable law, the product or element replacement, which may be new or reconditioned, is warranted during a period of ninety (90) days from the date of repair or until the end date of the initial warranty period, whichever is the earlier greater than ninety (90) days, it being specified that any period of immobilization of the Product of at least seven (7) days will be added to the warranty period remaining to run. This warranty does not apply in the following cases:

- Installation or use not in accordance with the instructions in the guide of the user,
- Incorrect connection or abnormal use of the Product, especially with non-compatible accessories, as indicated in the user guide,
- Product opened, modified or replaced by means of non-approved parts, serial number deleted, illegible, damaged,
- Normal wear, including normal wear and tear on accessories, batteries and displays,
- Failure to comply with the technical and safety standards in force in the area geographical use,
- Product having suffered a shock or a fall,
- Product damaged by lightning, electrical surge, heat source or radiation, water damage, exposure to conditions of temperature, humidity or other excessive ambient conditions or any other cause external to the product,
- Negligence or faulty maintenance,
- An intervention, a modification or a repair carried out by a not authorized by ATLINKS.

If the returned Product is not covered by the warranty, you will receive a quote from repair that will mention the cost of analysis and transportation costs that you will be charged if you want the Product returned to you. This guarantee is valid in the country in which you regularly purchased the Product, provided that the country is a member of the European Union. Subject to the legal provisions in force, all warranties other than described herein are expressly excluded.

TO THE MAXIMUM EXTENT PERMITTED BY APPLICABLE LAW,
A) THIS WARRANTY IS EXCLUSIVE TO ALL OTHER WARRANTIES EXPRESS OR IMPLIED, INCLUDING, BUT NOT LIMITED TO, WARRANTIES OF MERCHANTABILITY OR FITNESS FOR A PARTICULAR PURPOSE PARTICULAR;
B) ATLINKS DISCLAIMS LIABILITY FOR LOSS OR DETERIORATION OF DATA, LOSS OF USE LOST TO WIN, LOSS OF CHANCE, DEREVENUES OR INCOME, LOSS OF OPERATION, DAMAGES INDIRECT, CONSEQUENTIAL, CONSEQUENTIAL OR INCIDENTAL;
C) ATLINKS LIABILITY IS LIMITED TO THE VALUE OF PURCHASE OF PRODUCT EXCEPT HEAVIL OR UNINTENTIONAL FAULT AND EXCEPT DAMAGE BODY.

Atlinks Europe
147 Ave Paul Doumer
92500 Rueil-Malmaison France
RCS Nanterre 508 823 747
www.swissvoice.net
©Copyright Swissvoice International SA 2020
The Manufacturer reserves the right to modify this specifications of its products to make technical improvements or comply with new regulations.

Swissvoice is a trademark of Swissvoice International SA
Google, Android, and Google Play are trademarks of Google LLC.

Model : Swissvoice G50
A/W No. : 10002337 Rev.0 (EN)
Printed in China